

Data Sheet



Article number: 03442060

Description: Fluro Rod end GE 60EC-NIRO

Measures

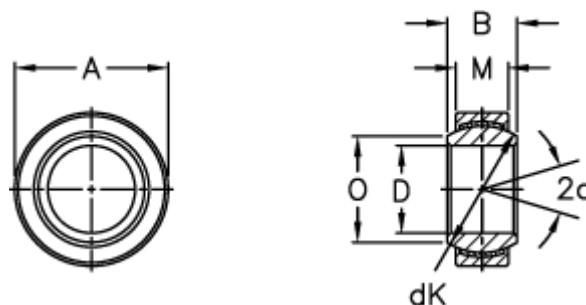

A	= 90 0 -0,015	Tilt angle = 6
B	= 44	Weight = 1000
D	= 60 0 -0,015	
dK	= 80	
Dynamic load C (kN)	= 481	
M	= 36	
O	= 66.8	
Static load C0 (kN)	= 935	